

**COGNEX**

# Lead with Speed

Setting the pace of machine vision

IN-SIGHT 3800 SERIES



## IN-SIGHT 3800 SERIES

All-in-one vision system meets all your vision needs

High speed, high resolution, high flexibility.  
The In-Sight® 3800 has it all.

This advanced vision system provides a powerful, yet easy-to-use, solution for automated inspections. Embedded with a full set of robust rule-based tools and innovative edge learning technology, In-Sight 3800 solves a range of manufacturing applications, from defect detection and assembly verification to character reading and more.

- Run more inspections in less time.
- Improve the accuracy of your results.
- Seamlessly scale your solution.



### Run more inspections in less time

Maximize throughput with high-speed processing and quick setup.

Tools running 2X faster than previous generation vision systems offer ultimate power and performance for any job

→ PAGE 4

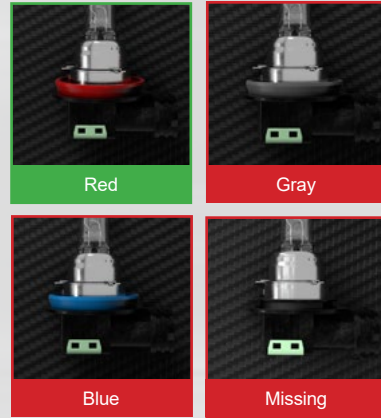
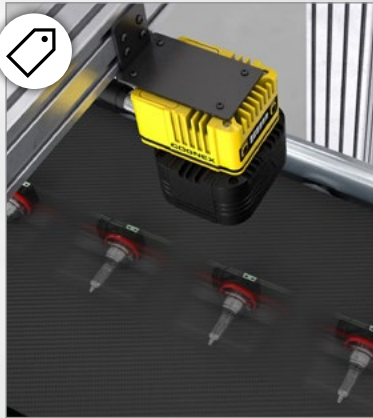

Advanced defect detection and OCR functionality automates a variety of tasks, from simple to complex

→ PAGE 4

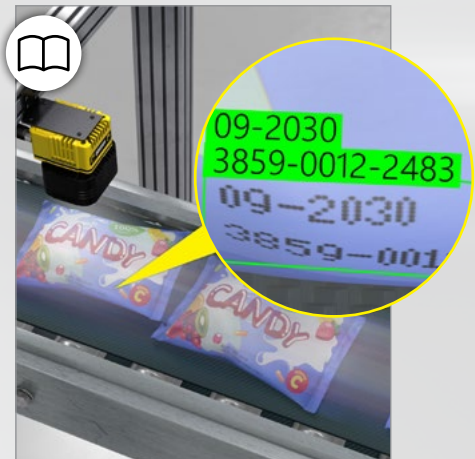

## Improve the accuracy of your results

Generate high-resolution, high-contrast images that detect even the most subtle defects.

**Integrated multi-color lighting accommodates a range of application requirements and operating conditions**

➔ PAGE 12

**Unique high-dynamic range plus (HDR+) technology optimizes image formation in a single acquisition**

➔ PAGE 13

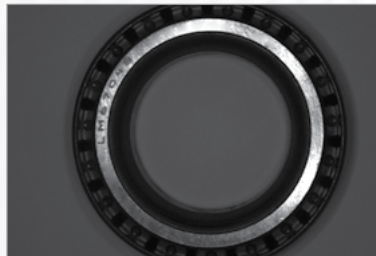

Without HDR

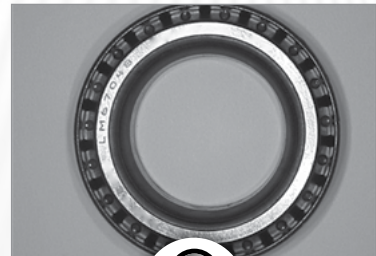

## Seamlessly scale your solution

Create jobs in a common software platform that supports scalability across In-Sight products and offers both point-and-click and advanced setup options.

**Robust spreadsheet-based job creation enables more control over tool parameters for complex tasks**

➔ PAGE 9

**Intuitive EasyBuilder® interface simplifies the training workflow for quick deployment**

➔ PAGE 10

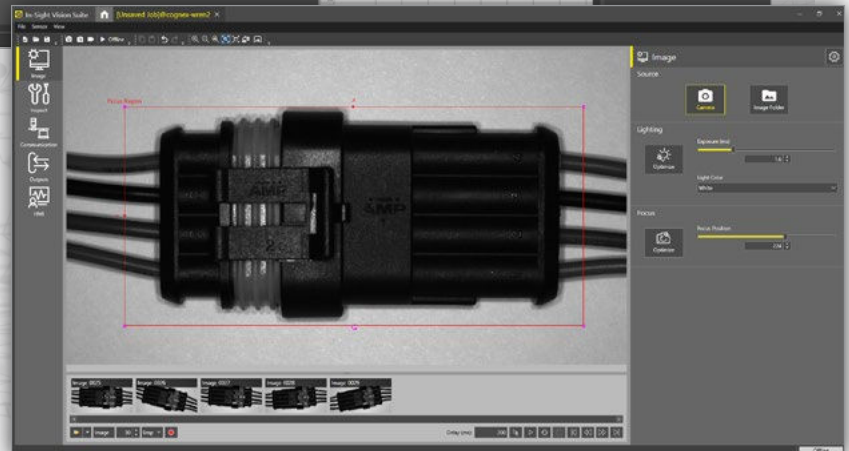
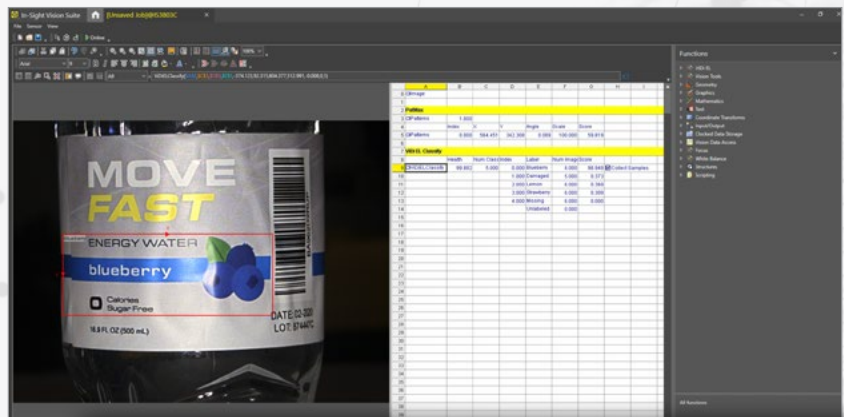

# Comprehensive toolset solves tasks of varying complexity

Integrating AI and rule-based tools in a single vision system, the In-Sight 3800 addresses a wide range of error-proofing applications. The tools can be used individually for simple jobs or combined to automate more challenging problems.

**2-6X FASTER**  
tool processing speeds  
than previous systems\*

**UP TO 2,500 PARTS/MINUTE**  
can be inspected  
with the In-Sight 3800



## AI tools

The In-Sight 3800 is embedded with powerful edge learning tools that leverage AI technology to train and process images on device, or “at the edge” of where the data is collected, to deliver accurate results in real time.

Edge learning tools are easy-to-use and simple to deploy with example-based training and no experience needed.

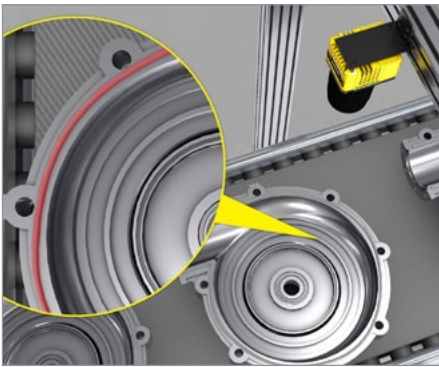

### ViDi EL Segment

Extract defects, regions, and objects from complex parts and backgrounds.

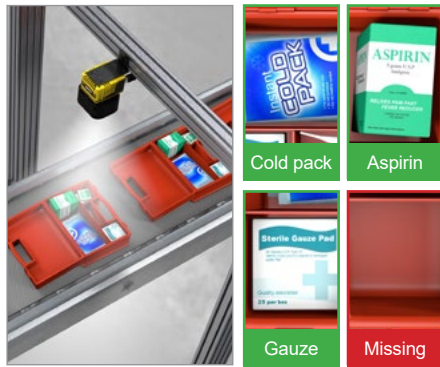

### ViDi EL Classify

Detect and sort parts based on multiple features or characteristics.

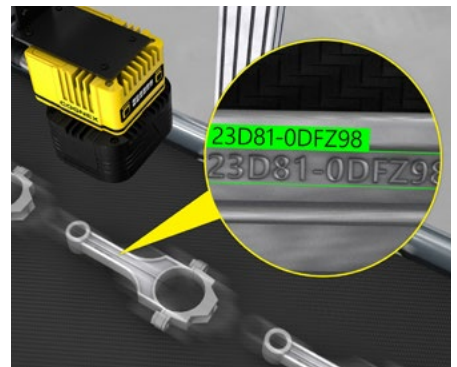

### ViDi EL Read

Read characters on reflective, low-contrast, and non-flat surfaces, including multi-line text.



### Training

ViDi EL tools can be trained in minutes, using as few as five to ten example images of the relevant classes or characters. Training is done directly on device, without the use of a central processing unit (CPU).

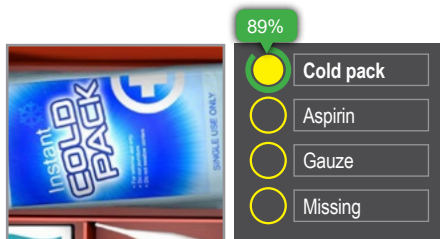

### Confidence score

Get real-time, visual feedback on the accuracy of your results. The confidence score verifies whether the ViDi EL tool correctly predicted the output, leading to less manual intervention and more reliable inspections.



\*Rule-based tool performance is 2x faster than In-Sight 7800/7900 series. AI tool performance is 3–6x faster than In-Sight 2800 series.



# Segmentation examples

**Automotive: Segment nested parts for targeted inspection**

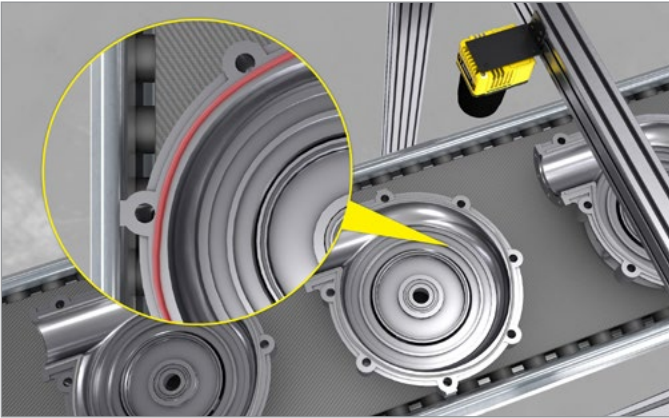

**Automotive: Identify subtle, variable defects**

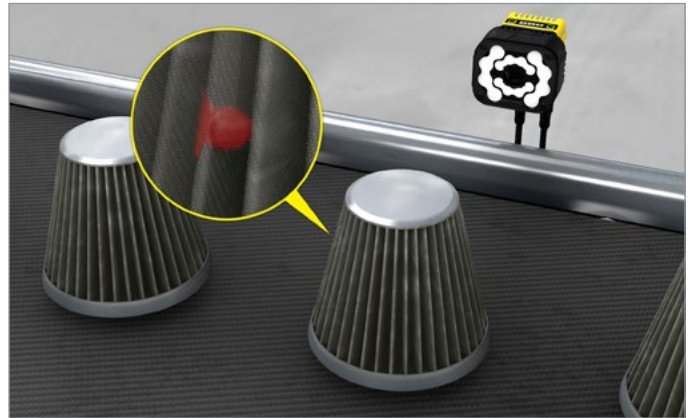

**Food and beverage: Detect and classify multiple types of defects**

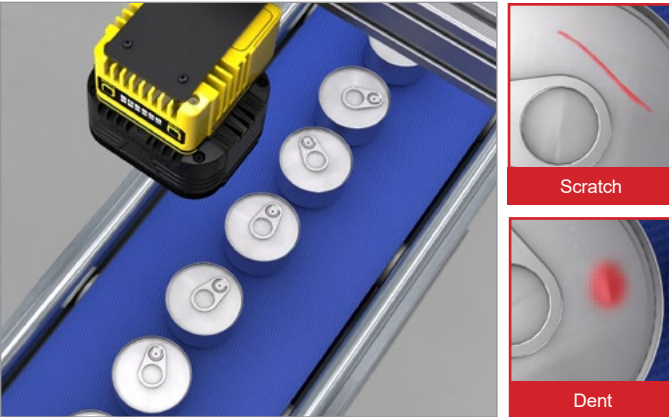

**Electronics: Extract different regions in a part and segment them by class**

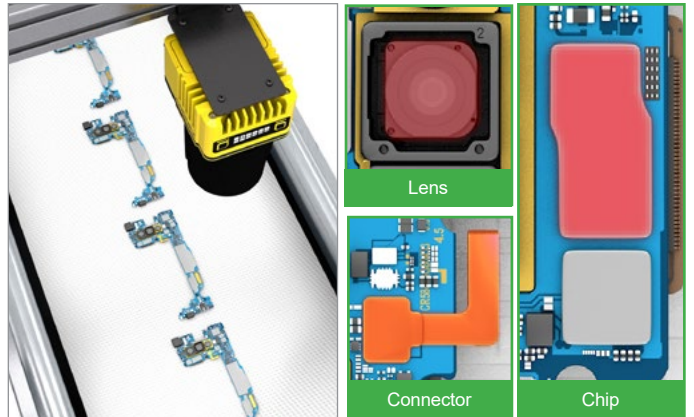

**Life sciences: Separate the liquid levels in test tube samples**

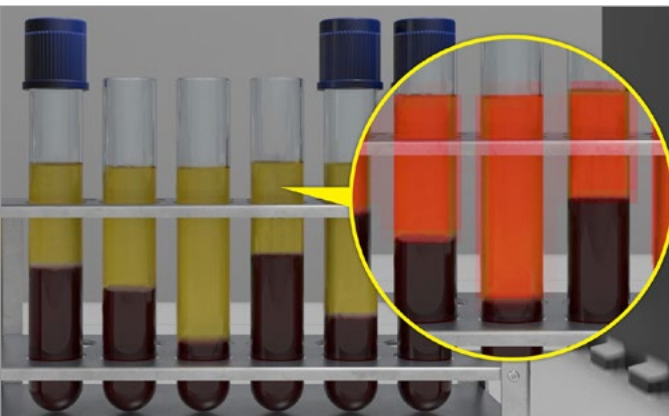

**Food and beverage: Ensure shape uniformity of products moving down the line**

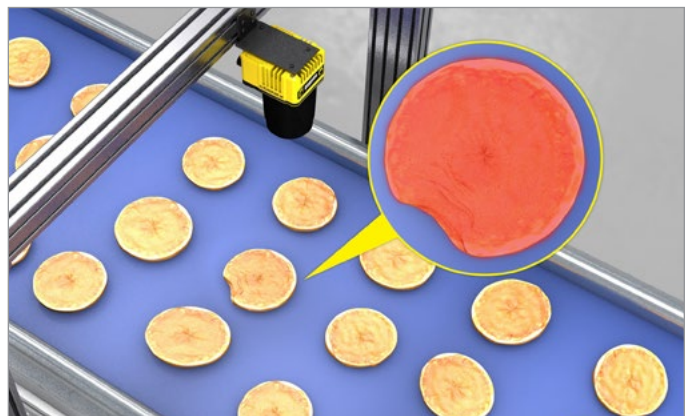



# Classification examples

Consumer products: Detect presence/absence in kitted products and run multi-ROI classification

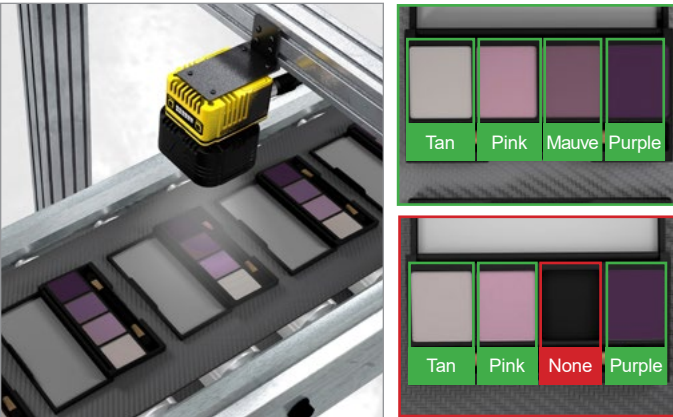

Electric vehicle (EV) batteries: Check parts for surface-level defects

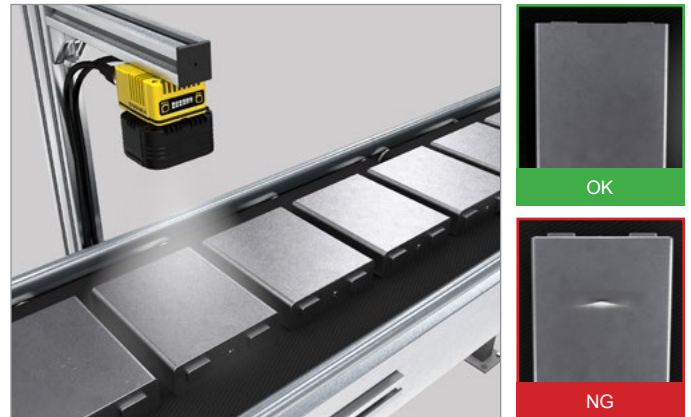

Automotive electronics: Detect presence/absence of components and classify defects

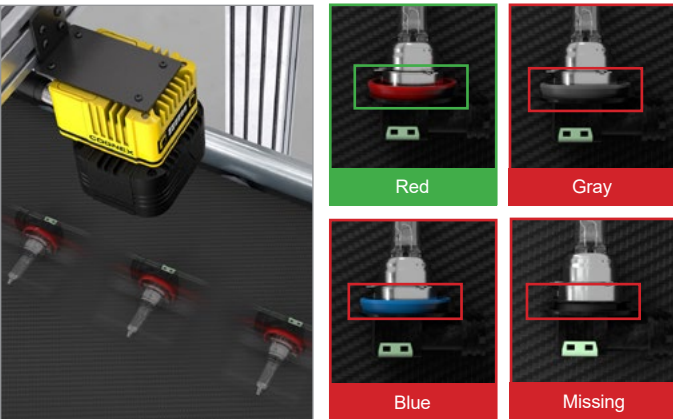

Automotive assembly: Inspect large parts for subtle defects

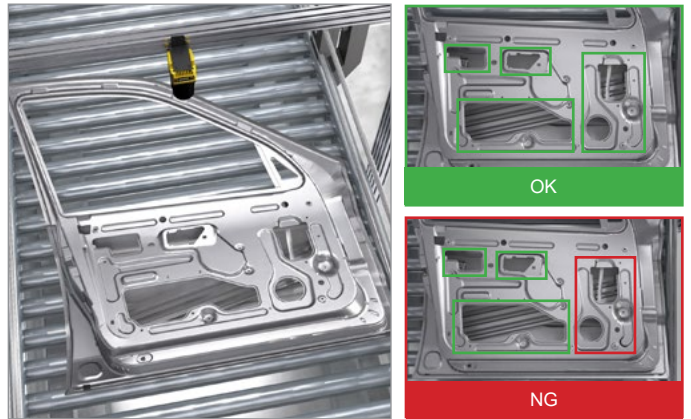

Consumer products: Classify scents or flavors on packaging

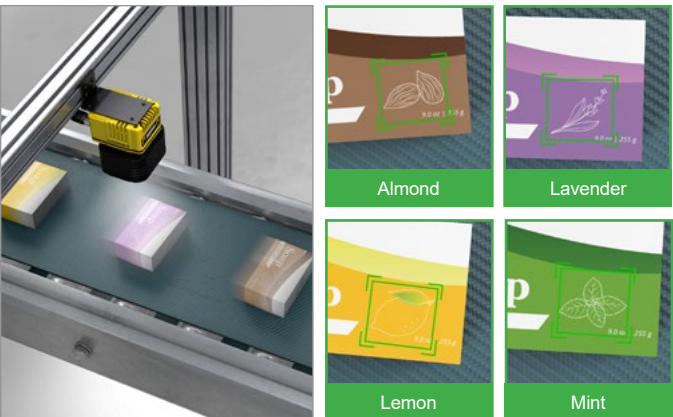

Food & beverage: Identify damaged or missing components





# OCR examples

Logistics: Read multiple lines of text on different package types



Consumer product: Decipher lot codes against variable backgrounds



Automotive: Read codes on low-contrast and reflective surfaces



Pharmaceutical: Perform on-line verification at high speeds



Automotive: Decipher hard-to-read text etched on metallic surfaces

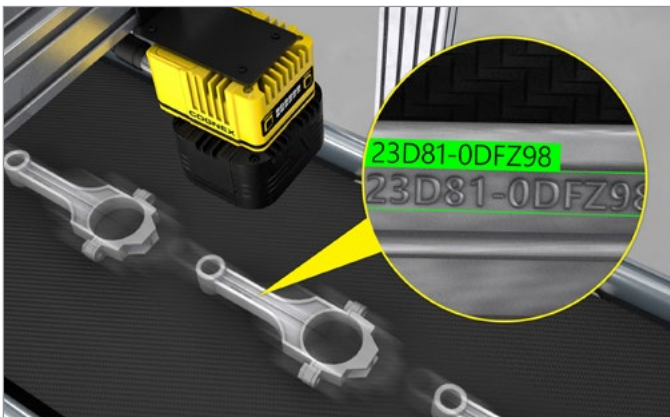

Food & beverage: Read lot codes on multiple products at the same time

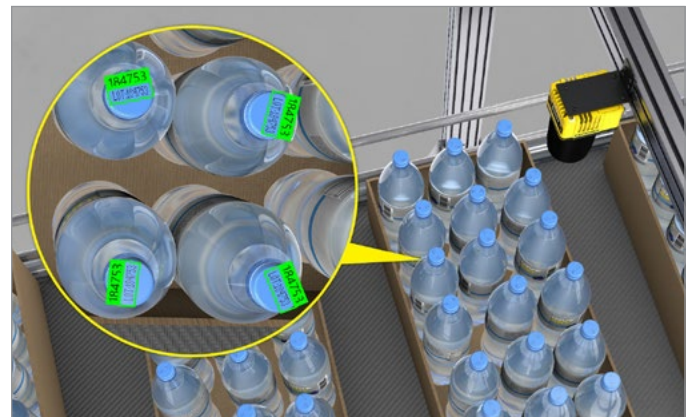



## Rule-based vision tools

In-Sight 3800 is also equipped with an extensive library of industry-proven traditional vision tools that allow you to measure distance and blobs, count pixels, and patterns, read codes, guide robots, perform math and logic, and more. These tools run 2X faster on In-Sight 3800 than previous generation products, so you can solve applications more quickly and accommodate faster line speeds.

**Barcode reading:** Read codes on curved surfaces



**Brightness:** Detect presence/absence of components based on varying brightness levels

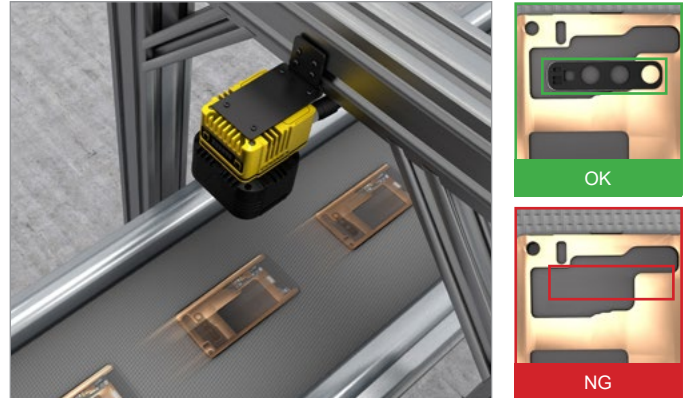

**Gauging:** Detect edges and measure the distance between them

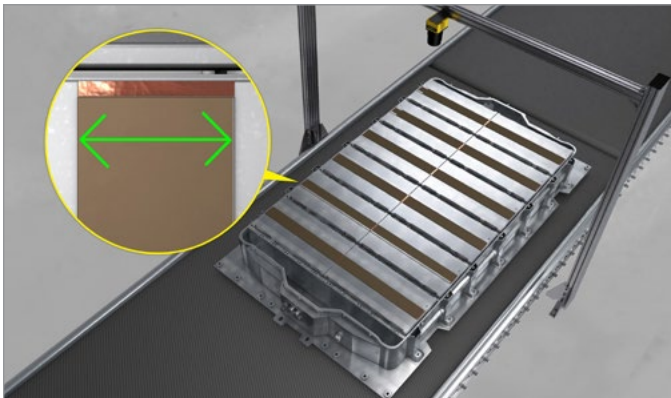

**Robotic guidance:** Pick and place finished products into bins



**Counting:** Count components to verify completeness



**Code reading and OCR:** Read multiple 2D codes and text across a large scanning area

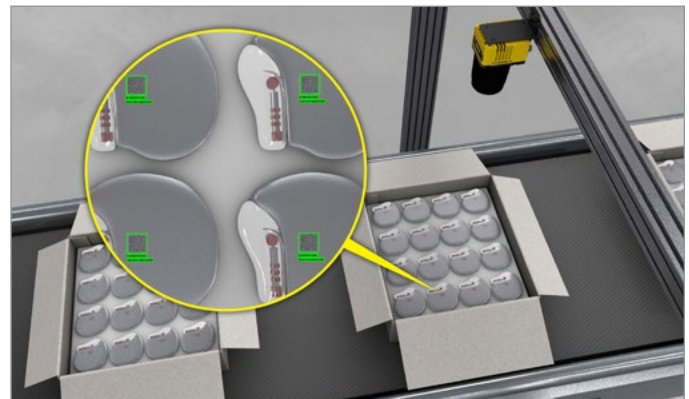



# Common software platform offers flexible development options

In-Sight Vision Suite software is common across all In-Sight products and includes two programming environments — spreadsheet and EasyBuilder — which allows you to seamlessly scale your solution as your business needs evolve.

## Spreadsheet guides users through advanced applications

The In-Sight spreadsheet interface allows you to quickly set up and run jobs without the need for programming. This robust development environment provides you with the flexibility to make critical adjustments to job parameters, so you can adapt your applications as your requirements change.

Powerful **spreadsheet** interface allows users to solve complex applications

|    | A                | B      | C         | D       | E          | F         | G      | H                                   | I               |
|----|------------------|--------|-----------|---------|------------|-----------|--------|-------------------------------------|-----------------|
| 0  | Image            |        |           |         |            |           |        |                                     |                 |
| 1  |                  |        |           |         |            |           |        |                                     |                 |
| 2  | PatMax           |        |           |         |            |           |        |                                     |                 |
| 3  | Patterns         | 1.000  |           |         |            |           |        |                                     |                 |
| 4  |                  | Index  | X         | Y       | Angle      | Scale     | Score  |                                     |                 |
| 5  | Patterns         | 0.000  | 564.451   | 342.308 | 0.069      | 100.000   | 59.819 |                                     |                 |
| 6  |                  |        |           |         |            |           |        |                                     |                 |
| 7  | VIDI EL Classify |        |           |         |            |           |        |                                     |                 |
| 8  |                  | Health | Num Class | Index   | Label      | Num Image | Score  |                                     |                 |
| 9  | VIDI EL Classify | 99.882 | 5.000     | 0.000   | Blueberry  | 8.000     | 98.949 | <input checked="" type="checkbox"/> | Collect Samples |
| 10 |                  |        |           | 1.000   | Damaged    | 5.000     | 0.373  |                                     |                 |
| 11 |                  |        |           | 2.000   | Lemon      | 6.000     | 0.369  |                                     |                 |
| 12 |                  |        |           | 3.000   | Strawberry | 6.000     | 0.309  |                                     |                 |
| 13 |                  |        |           | 4.000   | Missing    | 6.000     | 0.000  |                                     |                 |
| 14 |                  |        |           |         | Unlabeled  | 0.000     |        |                                     |                 |
| 15 |                  |        |           |         |            |           |        |                                     |                 |

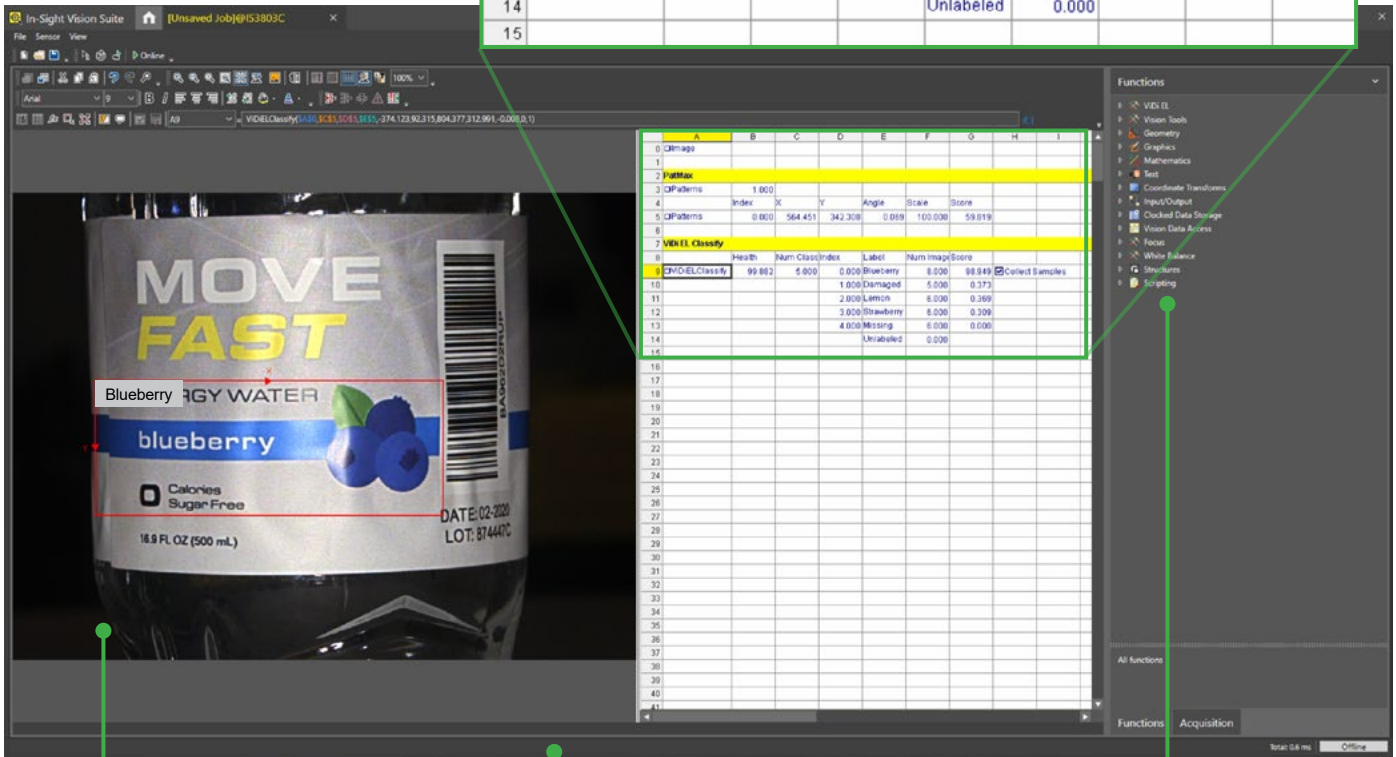

Easily review and recall files with image playback

Full I/O and communications function set streamlines factory integration

Full suite of AI- and rule-based vision tools

# EasyBuilder development environment simplifies setup and delivers rapid turnaround

With its point-and-click programming, the EasyBuilder interface within In-Sight Vision Suite is ideal for developing simple or common jobs. The intuitive process guides developers step-by-step through setup — from image capture to the final result and beyond — allowing both new and experienced users to configure vision applications.

Easy **step-by-step** application setup

Image-centric **point-and-click** functionality allows users to quickly set up tools

Capture images live or upload existing libraries

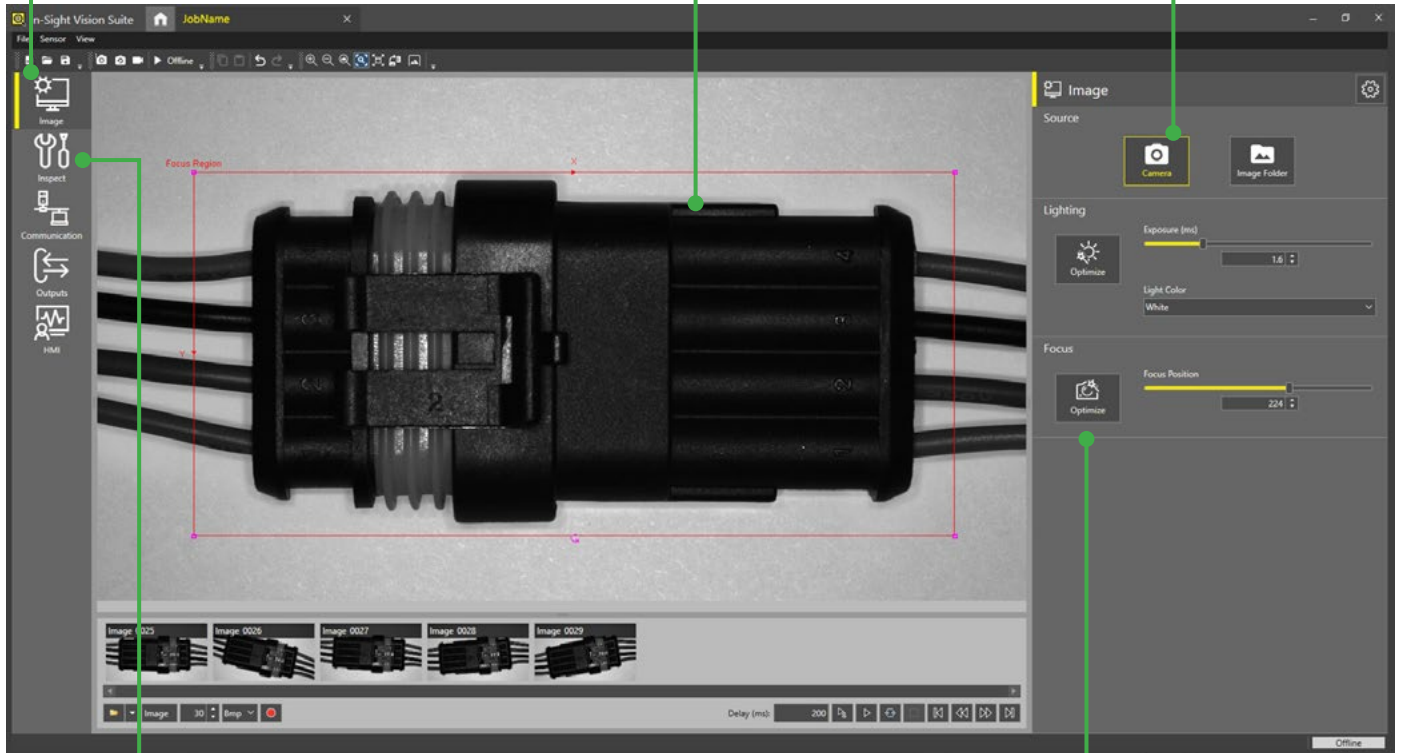

Comprehensive set of traditional rule-based vision tools and **innovative edge learning tools**

Fast, **2-click** image formation

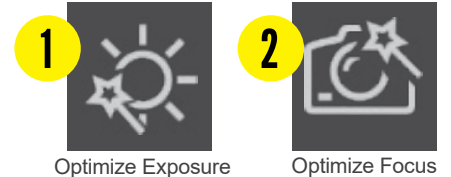

# Web-based HMI offers real-time application testing and optimization

The In-Sight 3800 provides access to a web-based human-machine interface (HMI) that enables runtime visualization. From the HMI, users can view inspection results and modify setup parameters to optimize their application.

EasyView displays tags from jobs in a simplified format

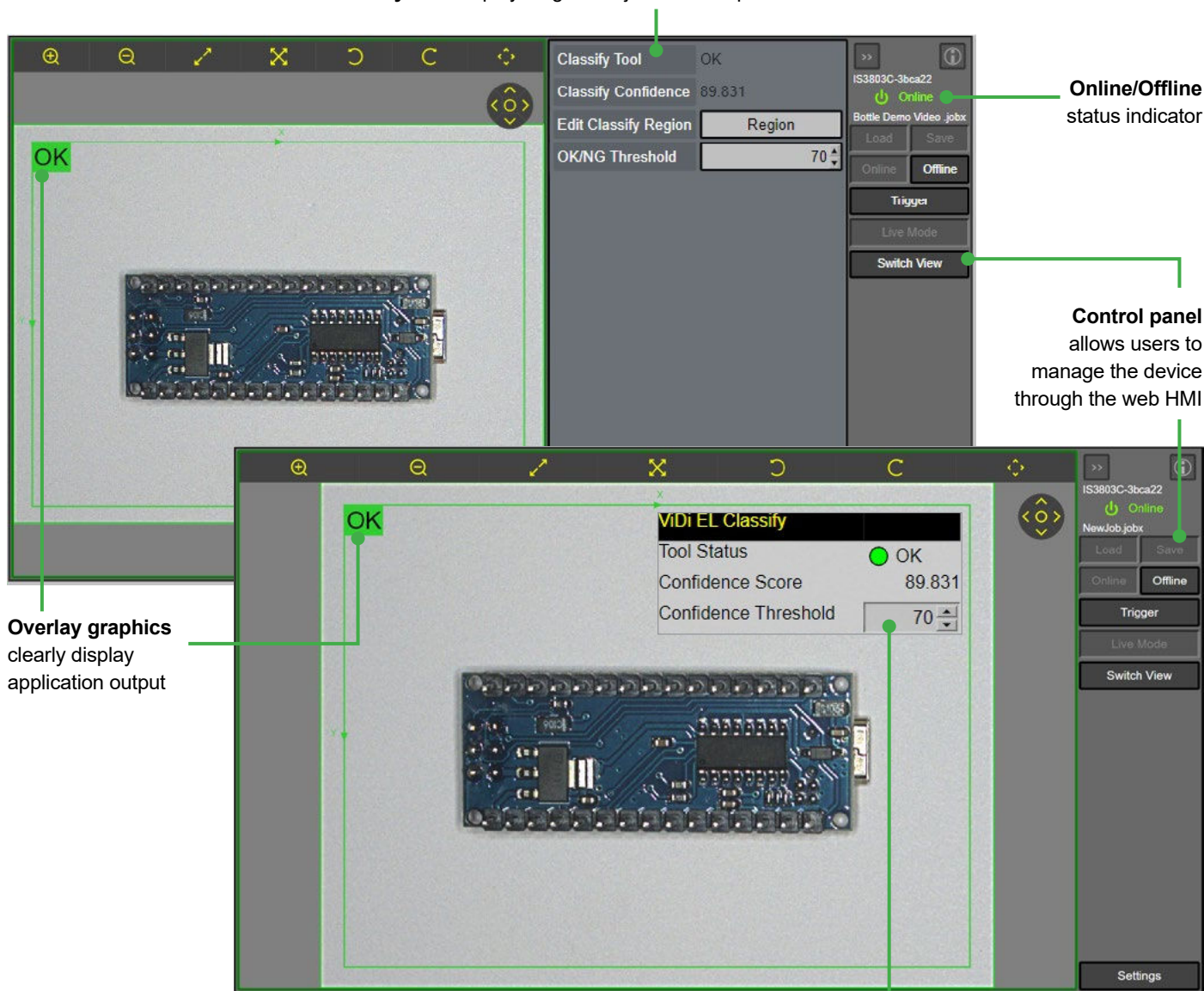

Overlay graphics clearly display application output

Online/Offline status indicator

Control panel allows users to manage the device through the web HMI

CustomView shows advanced settings from the spreadsheet

## Set up applications, directly on the factory floor, with VisionView Web

VisionView Web is a display panel that allows you to quickly train, update, and monitor jobs on the production line, without the need for a PC. Having this technology on the factory floor improves efficiency, facilitates easy device management, and provides real-time feedback for immediate process improvements.

[www.cognex.com/VisionView](http://www.cognex.com/VisionView)



# Full-featured vision system solves wide range of applications

The In-Sight 3800 is engineered with the entire suite of innovative Cognex vision tools and convenient features that deliver fast, reliable automation.



## Powerful, flexible integrated lighting

Multi-color (RGBW and IR) lighting options allow you to optimize image contrast for your application, regardless of operating conditions. Simply click a button in In-Sight Vision Suite to change the light color and generate high-resolution images for more accurate inspections.



Actual part

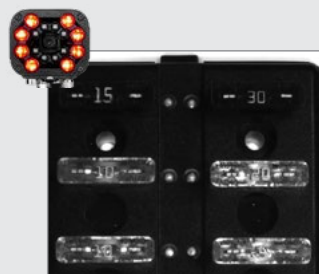

Red light:  
Numbers are unclear

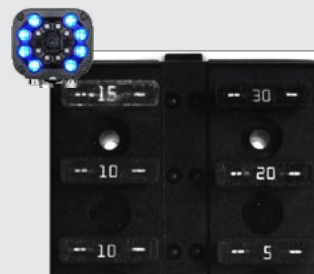

Blue light:  
Numbers are clear





# Innovative technology pushes the boundaries of HDR

HDR+ enhances the capabilities of HDR technology by optimizing contrast automatically. This creates a more uniformed, more detailed image in a single acquisition. Available in both monochrome and color options, HDR+ delivers higher contrast and image quality that allow you to:

- See features that were not visible before
- Reduce light intensity
- Increase depth of field

## Part inspection and OCR

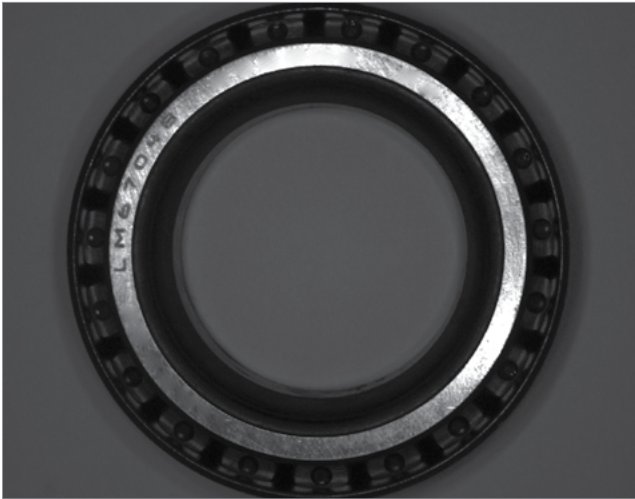

Without HDR: Embedded parts are unclear.

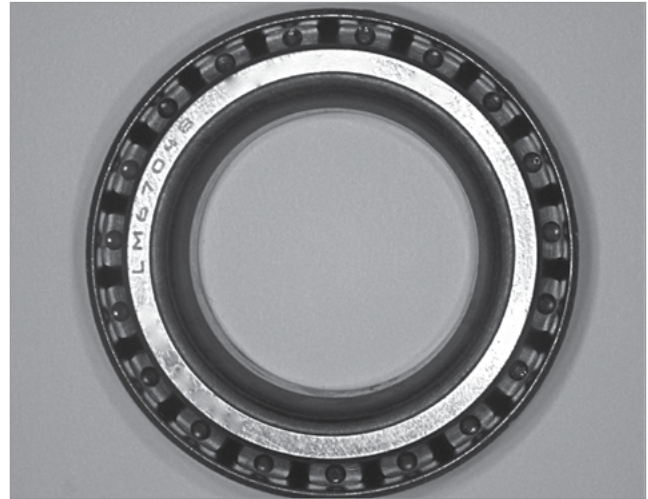

With HDR+: Serial code and bearings are both visible.

## Greater depth-of-field

HDR+ reduces over- and under-exposure, providing greater depth-of-field than standard HDR technology and conventional imaging sensors.

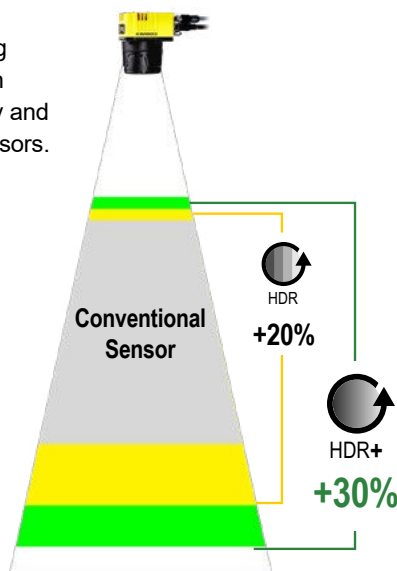

## Faster line speeds

HDR+ significantly reduces exposure times, enabling you to accommodate lines up to 80% faster.

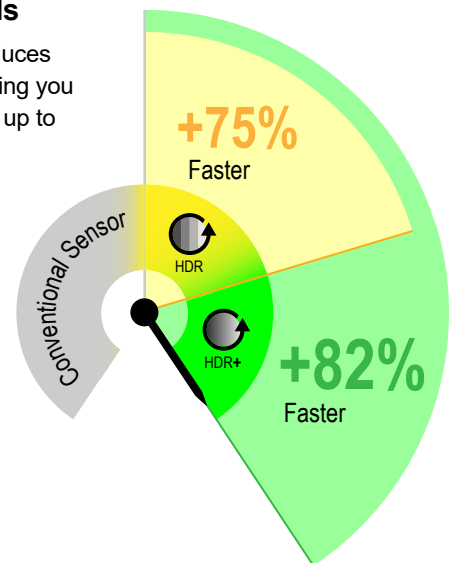

# Scalable architecture for current and future needs

The In-Sight 3800 series offers a variety of accessories and modular components. This flexibility enables users to adapt to keep up with changing demands, such as new changes, faster line speeds, and higher quality standards.

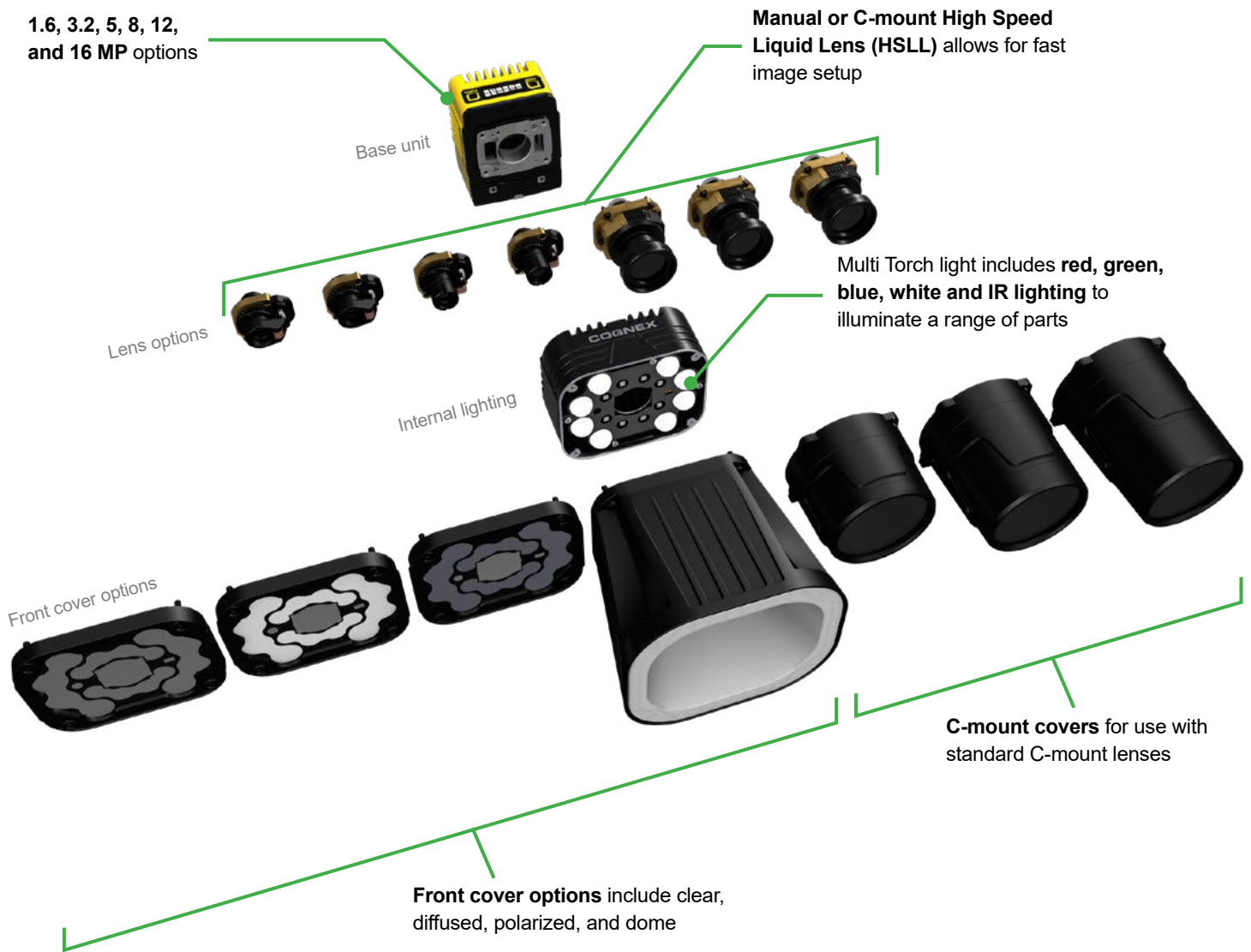

For additional details on accessory compatibility, please refer to page 19.

## Need help configuring your system?

Watch this explainer video that walks you step-by-step through the build-up process.



[www.cognex.com/in-sight-3800-buildup](http://www.cognex.com/in-sight-3800-buildup)



## IN-SIGHT 3800 SERIES SPECIFICATIONS

| Image Sensor                                 | IS3801M  | IS3801C      | IS3803M   | IS3803C      | IS3805M   | IS3805C      |
|--|--|--------------|---|--------------|---|--------------|
| Bit Depth                                    | 8-bit monochrome                                   | 24-bit color | 8-bit monochrome                                    | 24-bit color | 8-bit monochrome                                    | 24-bit color |
| Frames per Second (Maximum, Full Resolution) | 125 fps  | 52 fps       | 47 fps  | 30 fps       | 32 fps  | 21 fps       |
| Sensor Type                                  | 1/2.3" CMOS, global shutter                        |              | 1/1.8" CMOS, global shutter                         |              | 2/3" CMOS, global shutter                           |              |
| Sensor Properties                            | 6.3 mm diagonal, 3.45 x 3.45 $\mu$ m square pixels |              | 11.1 mm diagonal, 3.45 x 3.45 $\mu$ m square pixels |              | 11.1 mm diagonal, 3.45 x 3.45 $\mu$ m square pixels |              |
| Maximum Image Resolution (pixels)            | 1440 x 1080  |              | 2048 x 1536   |              | 2448 x 2048   |              |
| Electronic Shutter Speed                     | 19.5 $\mu$ s to 200,000 $\mu$ s                    |              | 25.1 $\mu$ s to 200,000 $\mu$ s                     |              | 19.1 $\mu$ s to 200,000 $\mu$ s                     |              |

| Image Sensor                                 | IS3808M   | IS3808C      | IS3812M   | IS3812C      | IS3816M   | IS3816C      |
|--|---|--------------|---|--------------|---|--------------|
| Bit Depth                                    | 8-bit monochrome                                    | 24-bit color | 8-bit monochrome                                    | 24-bit color | 8-bit monochrome                                    | 24-bit color |
| Frames per Second (Maximum, Full Resolution) | 24 fps  | 12 fps       | 22 fps  | 11 fps       | 18 fps  | 8 fps        |
| Sensor Type                                  | 2/3" CMOS, global shutter                           |              | 1/1.1" CMOS, global shutter                         |              | 1.1" CMOS, global shutter                           |              |
| Sensor Properties                            | 11.1 mm diagonal, 2.74 x 2.74 $\mu$ m square pixels |              | 14.0 mm diagonal, 2.74 x 2.74 $\mu$ m square pixels |              | 16.8 mm diagonal, 2.74 x 2.74 $\mu$ m square pixels |              |
| Maximum Image Resolution (pixels)            | 2840 x 2840   |              | 4096 x 3000   |              | 5320 x 3032   |              |
| Electronic Shutter Speed                     | 22 $\mu$ s to 200,000 $\mu$ s                       |              | 22 $\mu$ s to 200,000 $\mu$ s                       |              | 29.1 $\mu$ s to 200,000 $\mu$ s                     |              |

| Vision System                    |  |
|----------------------------------|--|
| Memory                           | 4 GB   |
| Lens Type                        | C-Mount, Cognex High Speed Liquid Lens Autofocus, or Cognex manual focus lens (used with Multi-Torch Illumination accessory).  |
| Trigger                          | 1 opto-isolated, acquisition trigger input.  |
| Discrete Inputs                  | 1 opto-isolated, acquisition trigger input.<br>Up to 3 general-purpose inputs when connected to the Breakout cable.  |
| Discrete Outputs                 | Up to 4 high-speed outputs when connected to the Breakout cable.   |
| Status LEDs                      | Pass/Fail LED and Indicator Ring, Network LED and Error LED.   |
| High Speed Liquid Lens Lifespan  | Number of Focus Cycles: 1800 M cycles  |
| Job/Program Memory               | 7.2 GB non-volatile flash memory; unlimited storage via remote network device.   |
| Image Processing Memory          | 512 MB SDRAM   |
| Network Communication            | 2 Ethernet ports, 10/100/1000 BaseT with auto MDIX. IEEE 802.3 TCP/IP Protocol.<br>1 USB-C port (supports direct connection to In-Sight Vision Suite on a PC, no factory floor protocols supported).<br>Supports DHCP, static, and link-local IP address configuration.  |
| Communication Protocols          | TCP/IP, PROFINET, EtherNet/IP, SLMP, ModbusTCP, (S)FTP, RS-232C  |
| Power Consumption                | 24 V DC $\pm$ 10%, 2.0 A maximum.  |
| Power Output                     | 24 V DC at 1.0 A maximum to external light.  |
| Material                         | Die-cast aluminum and zinc housing.  |
| Finish                           | Painted.   |
| Mounting                         | Four M3 threaded mounting holes. See Accessories for supported mounts.<br>Pattern: 38.5 x 58.5 mm (1.52 x 2.60 in)   |
| Weight                           | In-Sight 3800 with no accessories attached: 570 g (20.10 oz).<br>With 45 mm plastic C-Mount cover (COV-380-CMNT-45): 625 g (22.0 oz.) - no lens included.<br>With 60 mm plastic C-Mount cover (COV-380-CMNT-60): 635 g (22.4 oz.) - no lens included.<br>With 75 mm plastic C-Mount cover (COV-380-CMNT-75): 650 g (22.9 oz.) - no lens included.<br>With Multi-Torch Illumination, High Speed Liquid Lens (16 mm), and standard front cover: 840 g (29.6 oz.).<br>With Multi-Torch Illumination, High Speed Liquid Lens (16 mm), and dome attachment: 970 g (34.2 oz.). |
| Ambient/Environment Temperature  | 0° C to 40° C (32° F to 104° F)  |
| Storage Temperature              | -20° C to 80° C (-4° F to 176° F)  |
| Humidity                         | <95% non-condensing  |
| Protection                       | IP67 with all cables properly attached (or the provided connector plug installed), the IP67-rated cover, or Multi Torch attachment properly installed.   |
| Shock (Packaging)                | IEC 60068-2-27: 18 shocks (3 shocks in each polarity in each (X, Y, Z) axis) 80 Gs (800 m/s <sup>2</sup> at 11 ms, half-sinusoidal) with cables or cable plugs and a 150 gram or lighter lens attached.  |
| Vibration (Shipping and Storage) | IEC 60068-2-6: vibration test in each of the three main axis for 2 hours at 10 Gs (10 to 500 Hz at 100 m/s <sup>2</sup> / 15 mm) with cables or cable plugs and a 150 gram or lighter lens attached.   |
| Regulations/Conformity           | CE, FCC, KCC, TÜV SÜD NRTL, EU RoHS, China RoHS  |

# Field of view diagrams\*

Working distances  
Units: mm (in)

**1.6 MP with  
16 mm lens**

**3 MP with  
16 mm lens**

**5 MP with  
16 mm lens**

**Minimum**  
150 (5.9)



**Midpoint**  
500 (19.7)



**Maximum**  
2000 (78.7)



Working distances  
Units: mm (in)

**1.6 MP with  
24 mm lens**

**3 MP with  
24 mm lens**

**5 MP with  
24 mm lens**

**Minimum**  
200 (7.9)

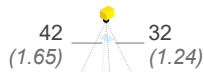

**Midpoint**  
1000 (39.4)



**Maximum**  
4000 (157.5)



\*Field of view diagrams are based on the minimum and maximum focus distances of the High Speed Liquid Lens. If using a High Speed Liquid Lens with the Multi Torch light accessory, the system will perform best at distances between 150–500 mm (5.9–19.7 in) in terms of light intensity/uniformity.

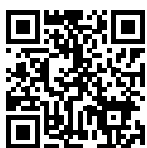

## Find the right lens for your application

The Cognex lens advisor makes it easy to select the right lens for your application. Plug in your specifications, hit "Calculate," and let the advisor take care of the rest.

[cognex.com/lens-advisor](https://cognex.com/lens-advisor)



**Working distances**  
Units: mm (in)

**Minimum**  
150 (5.9)

**Midpoint**  
500 (19.7)

**Maximum**  
1000 (39.4)

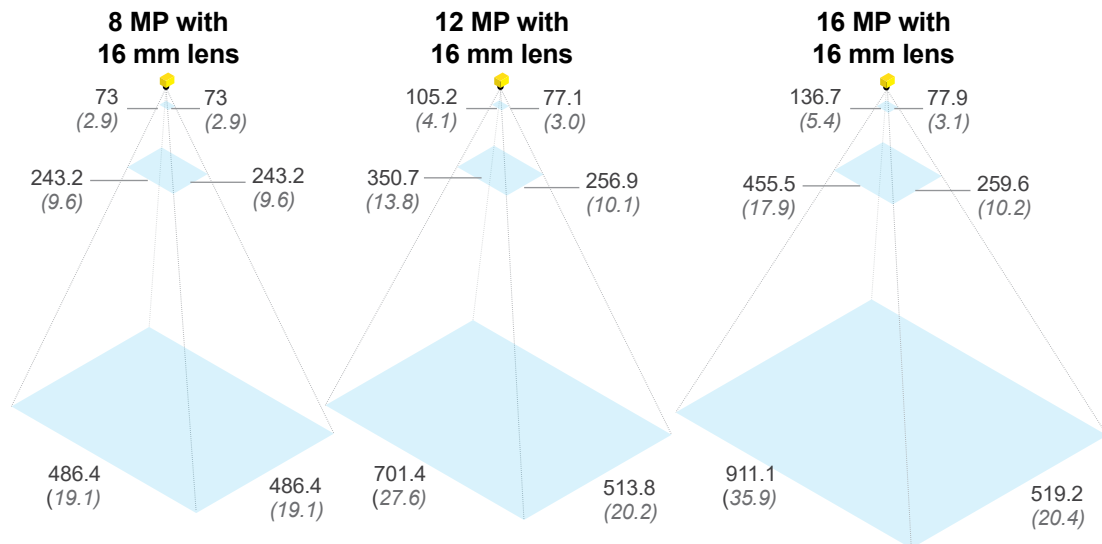

**Working distances**  
Units: mm (in)

**Minimum**  
300 (11.8)

**Midpoint**  
1000 (39.4)

**Maximum**  
4000 (157.5)

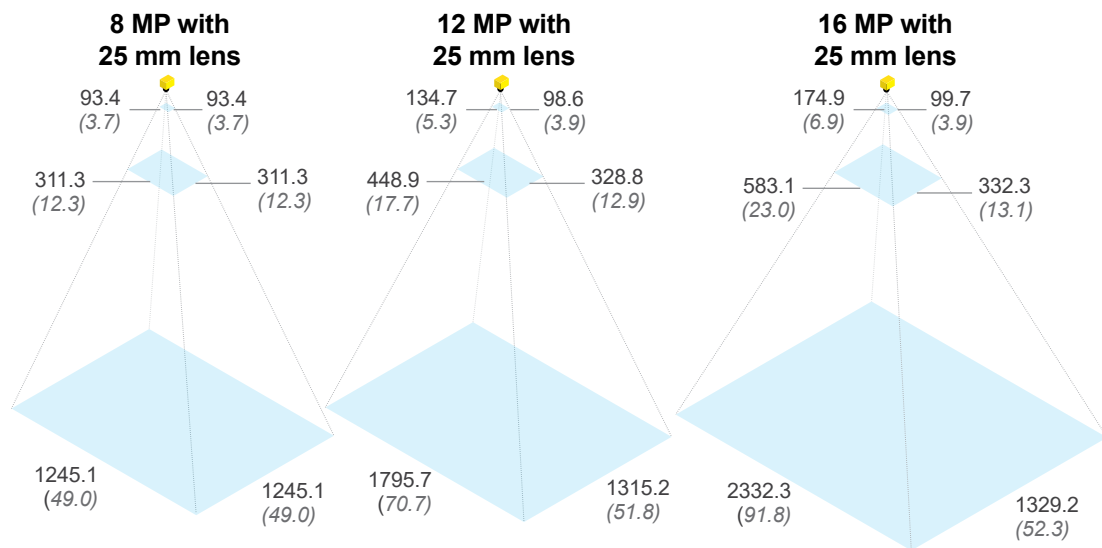

**Working distances**  
Units: mm (in)

**Minimum**  
300 (11.8)





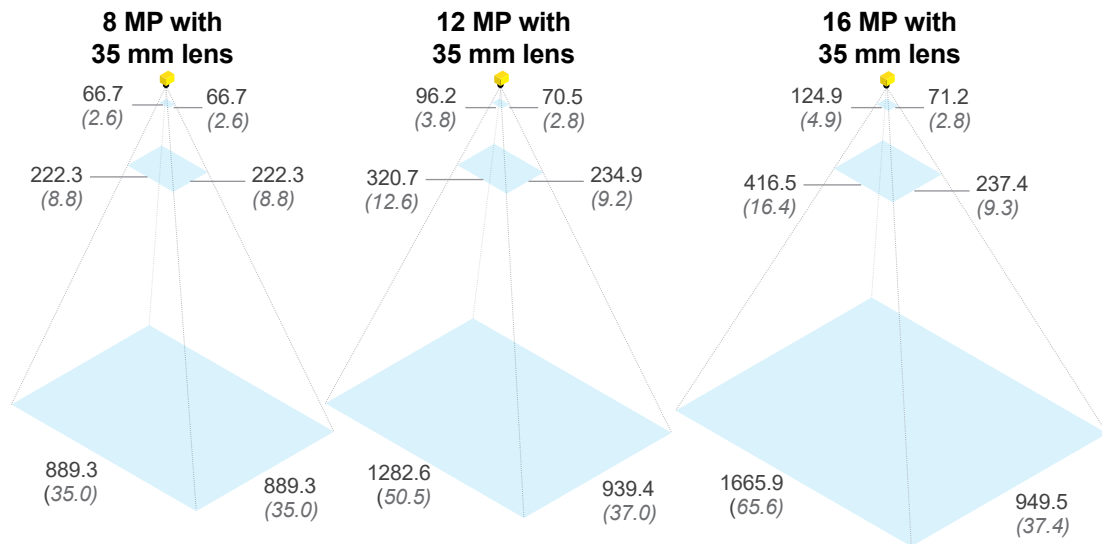



**Midpoint**  
1000 (39.4)

**Maximum**  
4000 (157.5)



\*Field of view diagrams are based on the minimum and maximum focus distances of the High Speed Liquid Lens. If using a High Speed Liquid Lens with the Multi Torch light accessory, the system will perform best at distances between 150–500 mm (5.9–19.7 in) in terms of light intensity/uniformity.





# Product IDs and descriptions\*



| IN-SIGHT 3800 SERIES  |                   |            |            |             |             |            |          |                                |
|---|-------------------|------------|------------|-------------|-------------|------------|----------|--------------------------------|
|   | Product ID        | Resolution | Mono/Color | Performance | Light       | Lens       | Cover    | Toolset                        |
|    | IS3801MP-00001-SA | 1.6 MP     | Mono       | Performance | None        | None       | None     | EB/SS <sup>1</sup> , all tools |
|   | IS3801CP-00001-SA | 1.6 MP     | Color      | Performance | None        | None       | None     | EB/SS, all tools               |
|   | IS3801MS-00001-SA | 1.6 MP     | Mono       | Standard    | None        | None       | None     | EB/SS, all tools               |
|   | IS3801CS-00001-SA | 1.6 MP     | Color      | Standard    | None        | None       | None     | EB/SS, all tools               |
|    | IS3801MP-14621-SA | 1.6 MP     | Mono       | Performance | Multi Torch | 16 mm HSSL | Diffused | EB/SS, all tools               |
|   | IS3801CP-14621-SA | 1.6 MP     | Color      | Performance | Multi Torch | 16 mm HSSL | Diffused | EB/SS, all tools               |
|   | IS3801MP-14821-SA | 1.6 MP     | Mono       | Performance | Multi Torch | 24 mm HSSL | Diffused | EB/SS, all tools               |
|   | IS3801CP-14821-SA | 1.6 MP     | Color      | Performance | Multi Torch | 24 mm HSSL | Diffused | EB/SS, all tools               |
|    | IS3803MP-00001-SA | 3.2 MP     | Mono       | Performance | None        | None       | None     | EB/SS, all tools               |
|   | IS3803CP-00001-SA | 3.2 MP     | Color      | Performance | None        | None       | None     | EB/SS, all tools               |
|   | IS3803MS-00001-SA | 3.2 MP     | Mono       | Standard    | None        | None       | None     | EB/SS, all tools               |
|   | IS3803CS-00001-SA | 3.2 MP     | Color      | Standard    | None        | None       | None     | EB/SS, all tools               |
|    | IS3803MP-14621-SA | 3.2 MP     | Mono       | Performance | Multi Torch | 16 mm HSSL | Diffused | EB/SS, all tools               |
|   | IS3803CP-14621-SA | 3.2 MP     | Color      | Performance | Multi Torch | 16 mm HSSL | Diffused | EB/SS, all tools               |
|   | IS3803MP-14821-SA | 3.2 MP     | Mono       | Performance | Multi Torch | 24 mm HSSL | Diffused | EB/SS, all tools               |
|   | IS3803CP-14821-SA | 3.2 MP     | Color      | Performance | Multi Torch | 24 mm HSSL | Diffused | EB/SS, all tools               |
|   | IS3805MP-00001-SA | 5 MP       | Mono       | Performance | None        | None       | None     | EB/SS, all tools               |
|   | IS3805CP-00001-SA | 5 MP       | Color      | Performance | None        | None       | None     | EB/SS, all tools               |
|   | IS3805MS-00001-SA | 5 MP       | Mono       | Standard    | None        | None       | None     | EB/SS, all tools               |
|   | IS3805CS-00001-SA | 5 MP       | Color      | Standard    | None        | None       | None     | EB/SS, all tools               |
|  | IS3805MP-14621-SA | 5 MP       | Mono       | Performance | Multi Torch | 16 mm HSSL | Diffused | EB/SS, all tools               |
|   | IS3805CP-14621-SA | 5 MP       | Color      | Performance | Multi Torch | 16 mm HSSL | Diffused | EB/SS, all tools               |
|   | IS3805MP-14821-SA | 5 MP       | Mono       | Performance | Multi Torch | 24 mm HSSL | Diffused | EB/SS, all tools               |
|   | IS3805CP-14821-SA | 5 MP       | Color      | Performance | Multi Torch | 24 mm HSSL | Diffused | EB/SS, all tools               |
|  | IS3808MX-00001-SA | 8 MP       | Mono       | Max         | None        | None       | None     | EB/SS, all tools               |
|   | IS3808CX-00001-SA | 8 MP       | Color      | Max         | None        | None       | None     | EB/SS, all tools               |
|   | IS3808MS-00001-SA | 8 MP       | Mono       | Standard    | None        | None       | None     | EB/SS, all tools               |
|   | IS3808CS-00001-SA | 8 MP       | Color      | Standard    | None        | None       | None     | EB/SS, all tools               |
|  | IS3812MX-00001-SA | 12 MP      | Mono       | Max         | None        | None       | None     | EB/SS, all tools               |
|   | IS3812CX-00001-SA | 12 MP      | Color      | Max         | None        | None       | None     | EB/SS, all tools               |
|   | IS3812MS-00001-SA | 12 MP      | Mono       | Standard    | None        | None       | None     | EB/SS, all tools               |
|   | IS3812CS-00001-SA | 12 MP      | Color      | Standard    | None        | None       | None     | EB/SS, all tools               |
|  | IS3816MX-00001-SA | 16 MP      | Mono       | Max         | None        | None       | None     | EB/SS, all tools               |
|   | IS3816CX-00001-SA | 16 MP      | Color      | Max         | None        | None       | None     | EB/SS, all tools               |
|   | IS3816MS-00001-SA | 16 MP      | Mono       | Standard    | None        | None       | None     | EB/SS, all tools               |
|   | IS3816CS-00001-SA | 16 MP      | Color      | Standard    | None        | None       | None     | EB/SS, all tools               |



\*This table includes only the most common product models. To get information on other available models, please contact Cognex Sales at [cognex.com/contact-sales](http://cognex.com/contact-sales).

# Components and accessories





| MULTI TORCH LIGHT   |                                 |   |
|---|---------------------------------|---|
|   | Product ID                      | Description   |
|  | 380-TORCH-MULTI-AF <sup>1</sup> | <b>Multi Torch Accessory Kit for autofocus lenses.</b> Includes: Multi Torch illumination module, mount for illumination module (CLN-CXXFXX-HSLL High-Speed Liquid Lenses only), diffused cover, illumination PCB, 2 mm hex tool. |
|   | 380-TORCH-MULTI-MF <sup>1</sup> | <b>Multi Torch Accessory Kit for manual focus lenses.</b> Includes: Multi Torch illumination module, mount for illumination module (CLN-CXXFXX manual lenses only), diffused cover, illumination PCB, 2 mm hex tool.              |





| MULTI TORCH FRONT COVERS  |                               |   |
|---|-------------------------------|---|
|   | Product ID                    | Description                             |
|    | 380-TORCH-COVDIF <sup>1</sup> | Multi Torch diffused front cover        |
|    | 380-TORCH-COVPOL <sup>1</sup> | Multi Torch cross-polarized front cover |
|   | 380-TORCH-COVCLR <sup>1</sup> | Multi Torch clear front cover           |
|  | 380-TORCH-DOME <sup>1</sup>   | Multi Torch dome attachment             |







| BANDPASS FILTERS  |                              |                                      |
|---|------------------------------|--------------------------------------|
|   | Product ID                   | Description                          |
|  | 380-TORCH-BP470 <sup>1</sup> | Blue bandpass filter for Multi Torch |
|  | 380-TORCH-BP635 <sup>1</sup> | Red bandpass filter for Multi Torch  |

| MOUNTING BRACKETS   |             |  |
|---|-------------|--|
|   | Product ID  | Description  |
|  | BKT-INS-01  | Mounting bracket with M3, M4 and 1/4 - 20 mounting holes                   |
|  | ISB-7000-7K | Converter mounting bracket with M3 socket head screws/wrench               |
|  | ISB-7000-5K | Converter mounting bracket with Phillips flat head M3 screws and M4 screws |

- 1 Compatible with IS3801/3803/3805.
- 2 Compatible with IS3801.
- 3 Compatible with IS3808/3812.
- 4 Compatible with IS3808/3812/3816.

| LENSES  |                                 |                              |
|---|---------------------------------|------------------------------|
|   | Product ID                      | Description                  |
|    | CLN-C16F8FS-HSLL <sup>1</sup>   | 16 mm HSSL                   |
|   | CLN-C24F6FS-HSLL <sup>1</sup>   | 24 mm HSSL                   |
|   | CLN-C16F8FS <sup>1</sup>        | 16 mm manual focus lens      |
|   | CLN-C24F6FS <sup>1</sup>        | 24 mm manual focus lens      |
|    | CLN-C16F65-HSLL-HR <sup>3</sup> | 16 mm HSSL - high resolution |
|   | CLN-C25F65-HSLL-HR <sup>3</sup> | 25 mm HSSL - high resolution |
|   | CLN-C35F06-HSLL-HR <sup>3</sup> | 35 mm HSSL - high resolution |
|    | LMC-ML-M0818HR <sup>2</sup>     | 8 mm Moritex HR series lens  |
|   | LMC-ML-M1218HR <sup>2</sup>     | 12 mm Moritex HR series lens |
|   | LMC-ML-M1618HR <sup>2</sup>     | 16 mm Moritex HR series lens |
|   | LMC-ML-M2518HR <sup>2</sup>     | 25 mm Moritex HR series lens |
|   | LMC-ML-M3520HR <sup>2</sup>     | 35 mm Moritex HR series lens |
|   | LMC-ML-M5025HR <sup>2</sup>     | 50 mm Moritex HR series lens |
|    | LMC-ML-M0625UR <sup>1</sup>     | 6 mm Moritex UR series lens  |
|   | LMC-ML-M0822UR <sup>1</sup>     | 8 mm Moritex UR series lens  |
|   | LMC-ML-M1218UR <sup>1</sup>     | 12 mm Moritex UR series lens |
|   | LMC-ML-M1616UR <sup>1</sup>     | 16 mm Moritex UR series lens |
|   | LMC-ML-M2516UR <sup>1</sup>     | 25 mm Moritex UR series lens |
|   | LMC-ML-M3520UR <sup>1</sup>     | 35 mm Moritex UR series lens |
|  | LMC-ML-M5025UR <sup>1</sup>     | 50 mm Moritex UR series lens |
|   | LMC-ML-U0618SR <sup>4</sup>     | 6 mm Moritex SR series lens  |
|   | LMC-ML-U1217SR <sup>4</sup>     | 12 mm Moritex SR series lens |
|   | LMC-ML-U1615SR <sup>4</sup>     | 16 mm Moritex SR series lens |
|   | LMC-ML-U2515SR <sup>4</sup>     | 25 mm Moritex SR series lens |
|   | LMC-ML-U3518SR <sup>4</sup>     | 35 mm Moritex SR series lens |
|   | LMC-ML-U5022SR <sup>4</sup>     | 50 mm Moritex SR series lens |

| LENS COVERS   |                   |                           |
|---|-------------------|---------------------------|
|   | Product ID        | Description               |
|  | COV-380-CMNT-45   | 45 mm plastic lens cover  |
|  | COV-380-CMNT-60   | 60 mm plastic lens cover  |
|  | COV-380-CMNT-75   | 75 mm plastic lens cover  |
|  | COV-7000-CMNT-LGX | 30 mm lens cover extender |

| CABLES  |                    |   |
|---|--------------------|---|
|   | Product ID         | Description   |
|  | IVSL-5PM12-JXXX    | External light cable, yellow (300 mm, 500 mm, 1000 mm, 2000 mm)     |
|  | IVSL-M12-NSB-XXX   | External light cable, black (300 mm, 1000 mm, 2000 mm)              |
|  | CCB-M12LTF-XX      | External light cable, gray (0.5 m, 1 m, 2 m, 5 m)                   |
|  | ICQ-CB-0.5-IFL-M12 | Black M12 to M12 cable with a small in-line capacitor (2 m)         |
|  | CCB-84901-2001-XX  | Ethernet cable, X-coded M12-8 to RJ-45 (2 m, 5 m, 10 m, 15 m, 30 m) |
|   | CCB-84901-2RBT-XX  | Ethernet cable, X-coded M12-8 to RJ-45 (2 m, 5 m, 10 m)             |
|  | CCB-PWRIO-XX       | Breakout cable, M12-12 to flying lead (5 m, 10 m, 15 m)             |

| VISIONVIEW WEB  |            |                                |
|---|------------|--------------------------------|
|   | Product ID | Description                    |
|  | VWV-P      | VV Web HDMI Panel              |
|   | VWV-H-AU   | CFKIT, VV Web HDMI with AU PS  |
|   | VWV-H-EU   | CFKIT, VV Web HDMI with EU PS  |
|   | VWV-H-NOM  | CFKIT, VV Web HDMI with NOM PS |
|   | VWV-H-UK   | CFKIT, VV Web HDMI with UK PS  |
|   | VWV-H-US   | CFKIT, VV Web HDMI with US PS  |

## Dimensions

Units: mm, [in]

### In-Sight 3800 base unit

[Download CAD files](#)

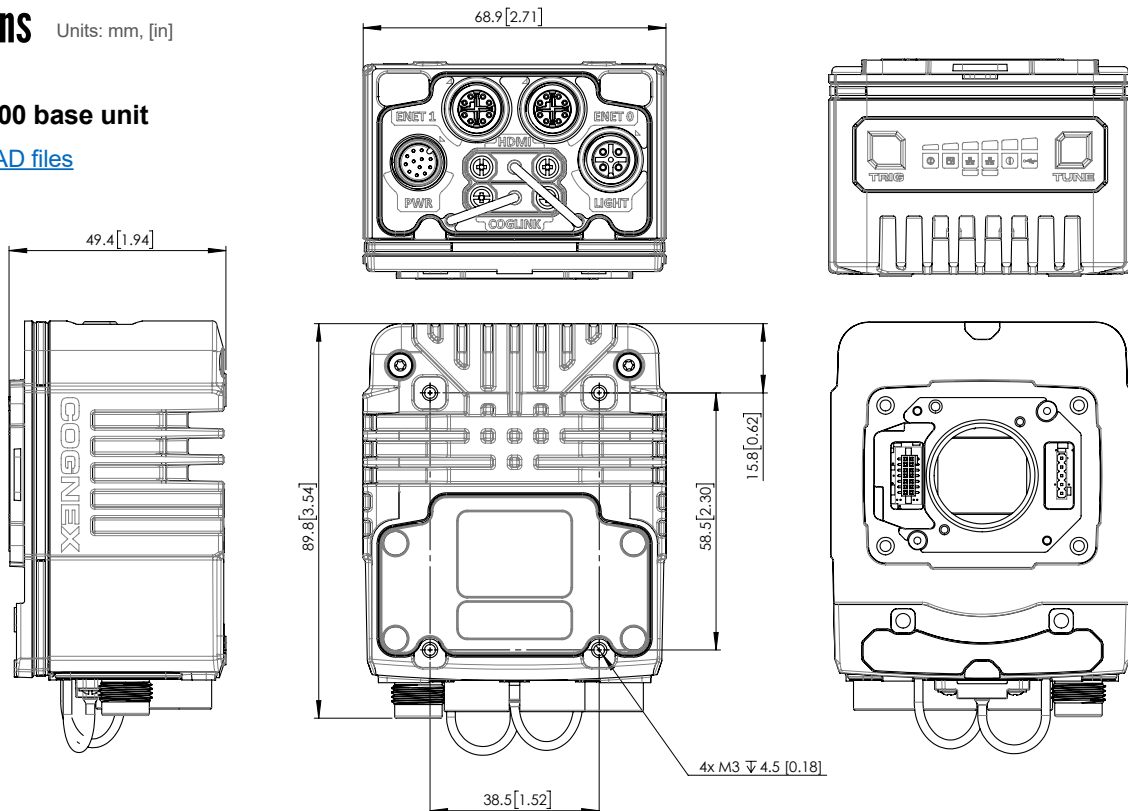

## In-Sight 3800 with Multi Torch

[Download CAD files](#)

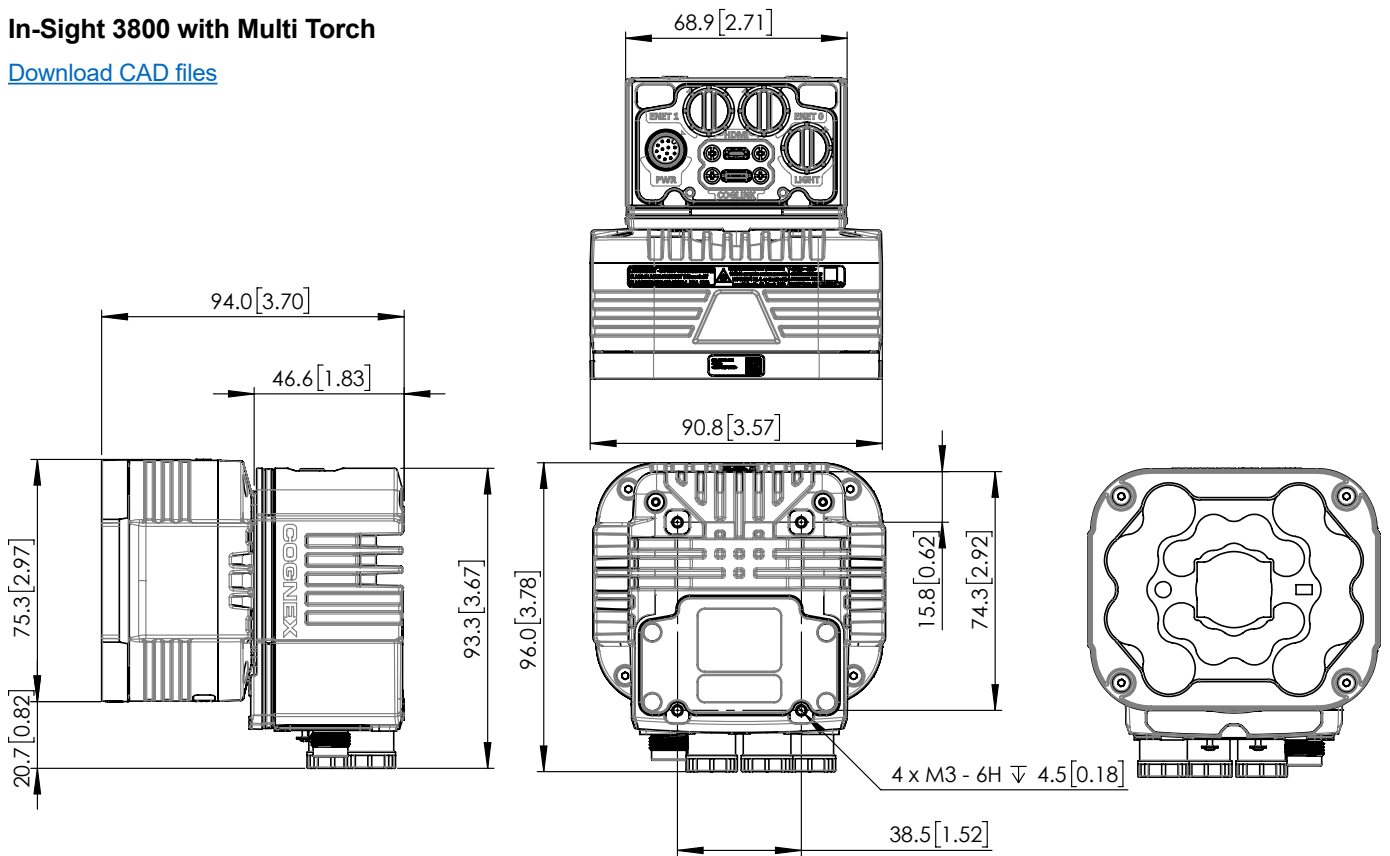

## In-Sight 3800 with Dome

[Download CAD files](#)

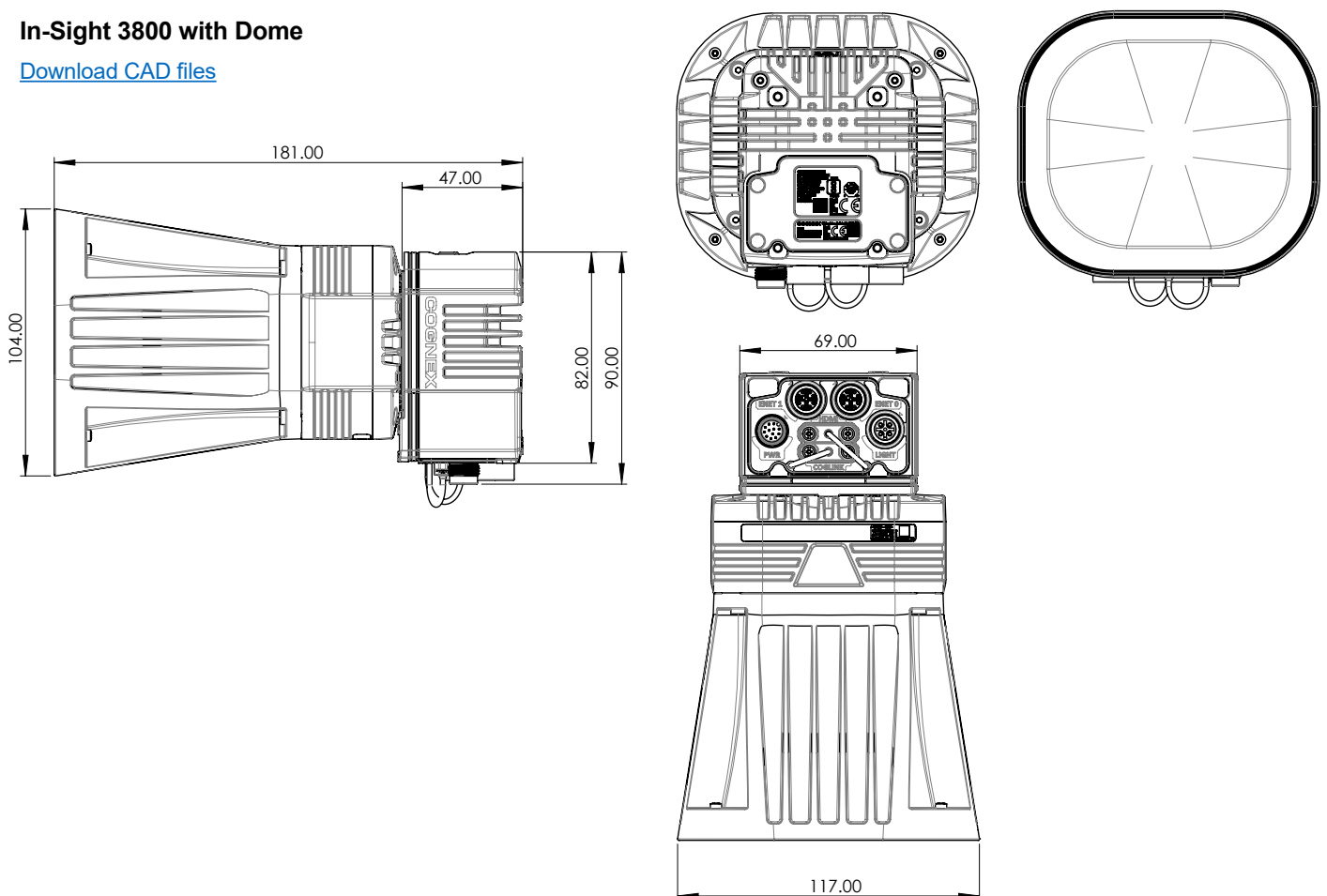

## In-Sight 3800 with C-mount

### 45 mm C-mount cover

[Download CAD files](#)

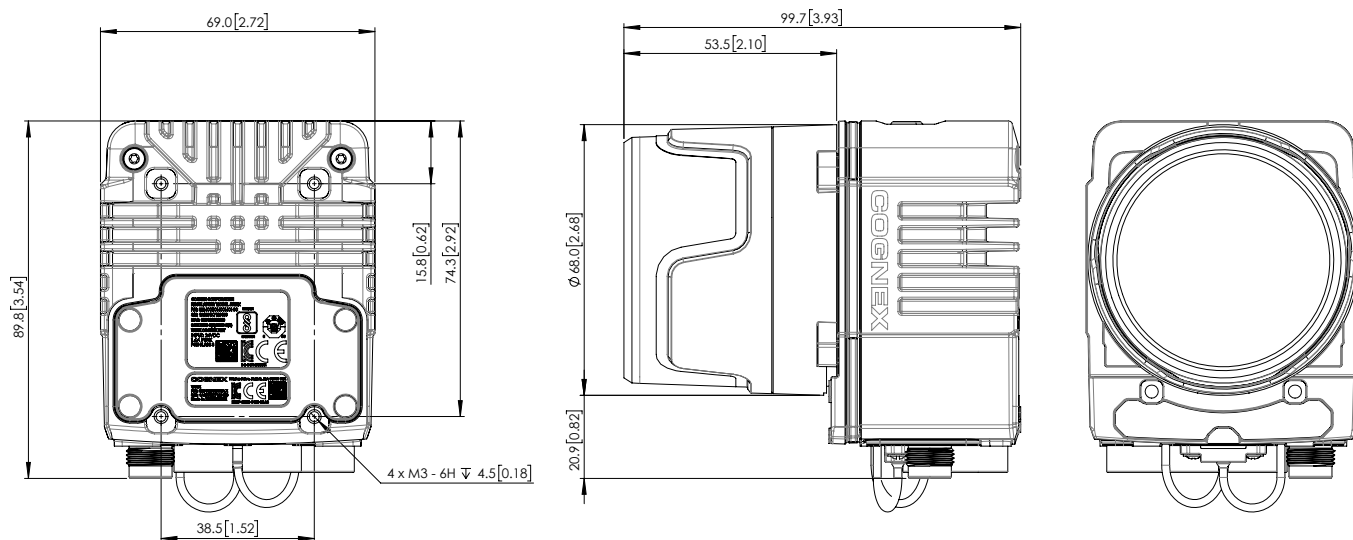

### 60 mm C-mount cover

[Download CAD files](#)

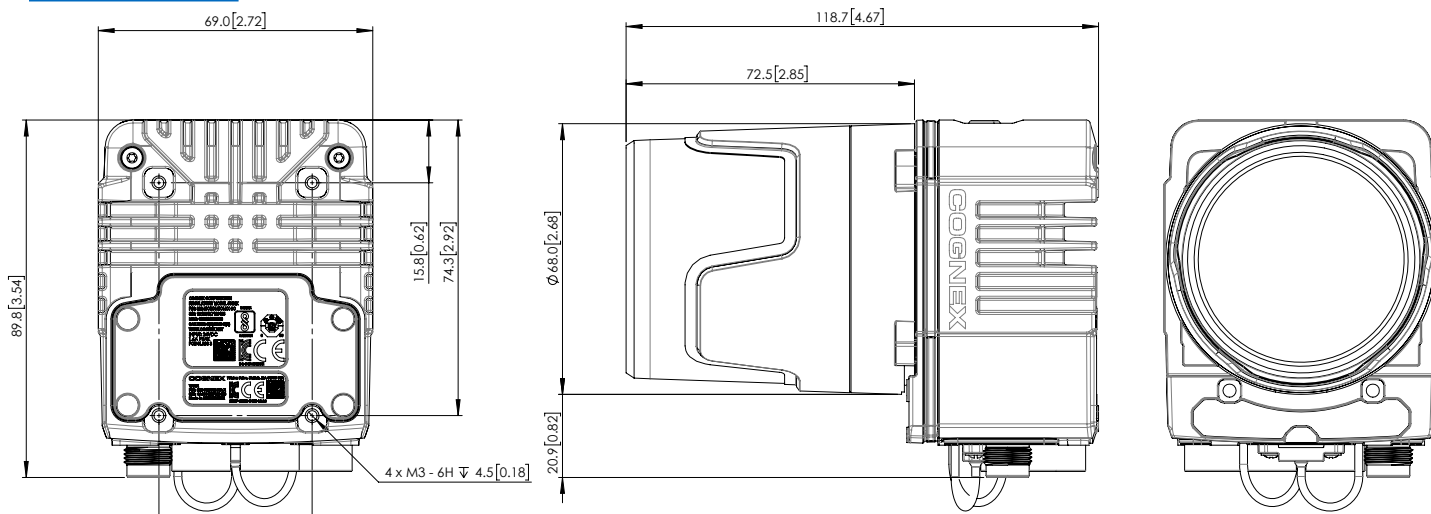

## 75 mm C-mount cover

[Download CAD files](#)

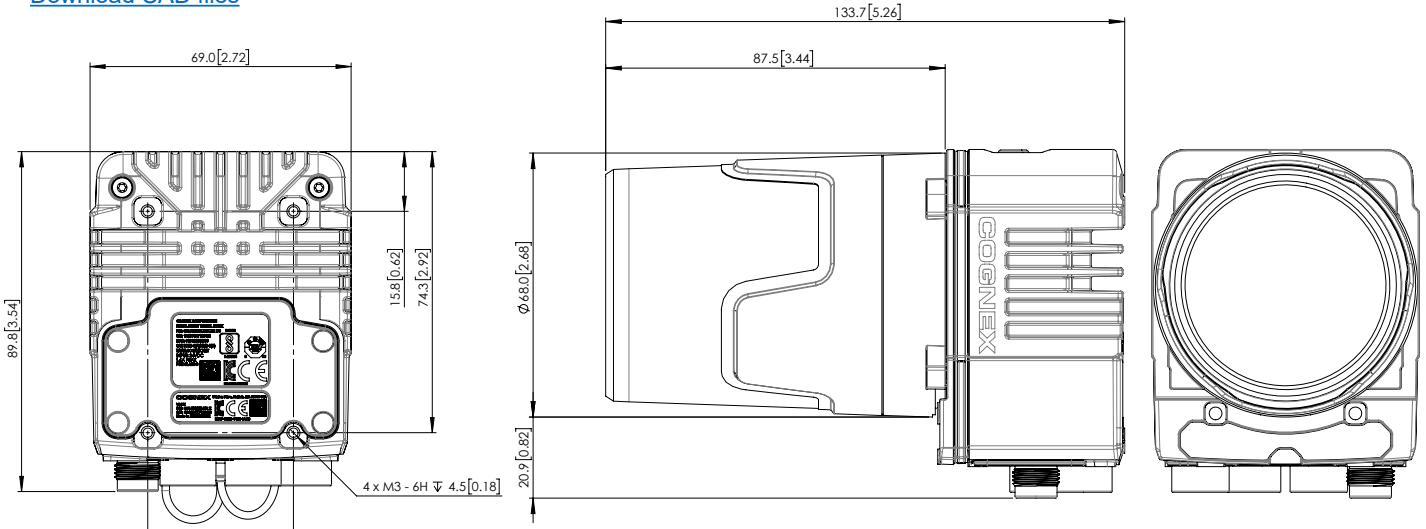

## Cable bend radius

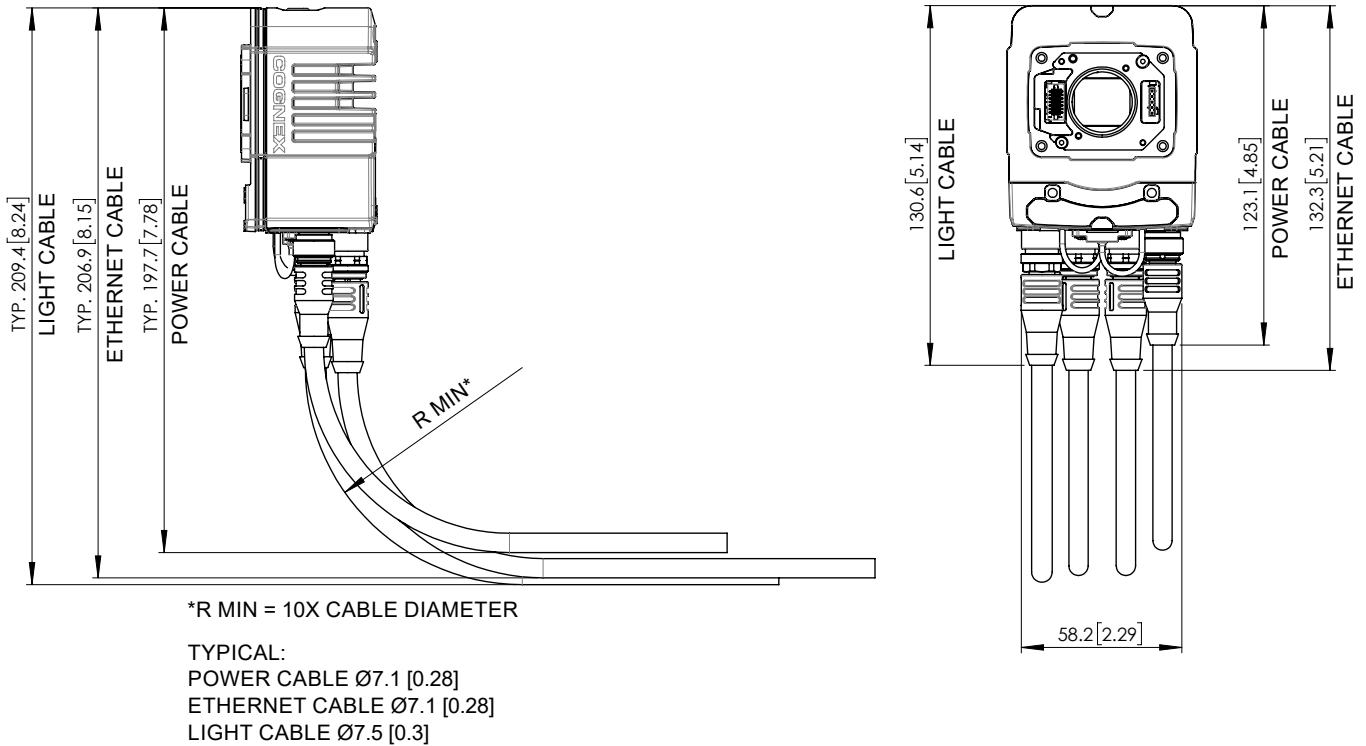

# COGNEX

Companies around the world rely on Cognex vision and barcode reading solutions to optimize quality, drive down costs, and control traceability.

Corporate Headquarters One Vision Drive Natick, MA 01760 USA

### Regional Sales Offices

#### Americas

North America +1 844 999 2469  
Brazil +55 11 4210 3919  
Mexico +800 733 4116

#### Europe

Austria +43 800 28 16 32  
Belgium +32 289 370 75  
Czechia +420 800 023 519  
France +33 1 76 54 93 18  
Germany +49 721 958 8052  
Hungary +36 800 80291

Ireland +353 21 421 7500  
Italy +39 02 3057 8196  
Netherlands +31 207 941 398  
Poland +48 717 121 086  
Romania +40 741 041 272  
Spain +34 93 299 28 14  
Sweden +46 21 14 55 88  
Switzerland +41 445 788 877  
Turkey +90 216 900 1696  
United Kingdom +44 121 29 65 163

#### Asia-Pacific

Australia +61 2 7202 6910  
China +86 21 5875 1133

India +91 7305 040397  
Indonesia +62 21 3076 1792  
Japan +81 3 5977 5400  
Korea +82 2 539 9047  
Malaysia +6019 916 5532  
New Zealand +64 9 802 0555  
Philippines +63 2 8539 3990  
Singapore +65 3158 3322  
Taiwan +886 02 7703 2848  
Thailand +66 6 3230 9998  
Vietnam +84 98 2405167

© Copyright 2023, Cognex Corporation. All information in this document is subject to change without notice. All Rights Reserved. Cognex, In-Sight, and EasyBuilder are registered trademarks of Cognex Corporation. ViDi is a trademark of Cognex Corporation. All other trademarks are property of their respective owners. Lit. No. IS3800DS-12-2023

[www.cognex.com](http://www.cognex.com)